

Data Sheet



Article number: 021500700076

Description: Sealing Clamp S 76 W5

Measures

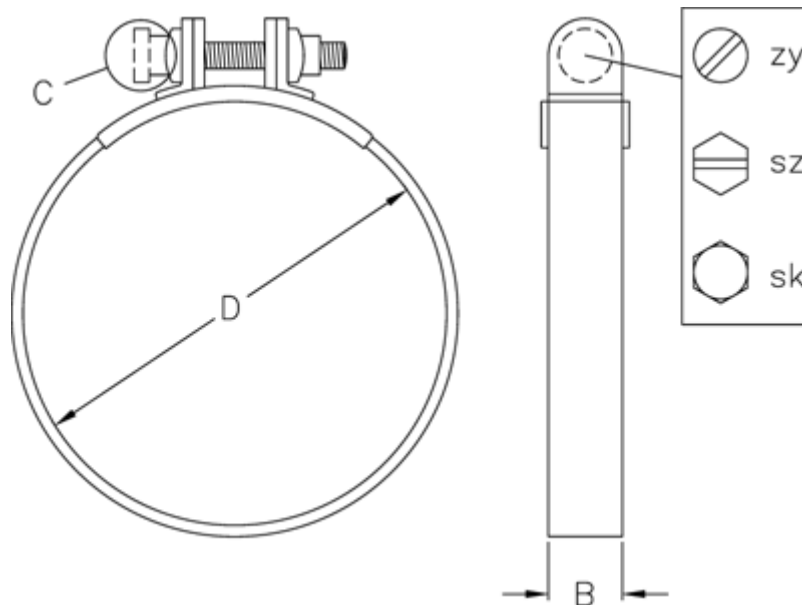

C (screw type) = SZ

Diameter D = 76

Width B = 20